

Instruction Manual

Mode d'emploi

Manual instructivo

Manuale d'uso

Bedienungsanleitung

English

Français

Español

Italiano

Deutsch



Contents

Startup Guide	1
Safety Precautions.....	2
Wireless Communication Function.....	3
Accessories.....	3
Parts Names	4
Installing (or Replacing) the Batteries	5
Registering with a Receiver (Pairing)	6
Skip Registering with a Receiver (Pairing).....	7
Setting the Unit	8
Measuring Your Weight	9
Other Functions	11
Specifications.....	13
Before Requesting Service	14
Maintaining the Scale	14

Dear Customers

Congratulations on purchasing a state-of-the-art A&D health scale, one of the most advanced health scales available today. Designed for ease of use and accuracy, this device will facilitate your daily weight management regimen. We recommend that you read through this manual carefully before using the device for the first time.

▶▶ Startup Guide

Get Started

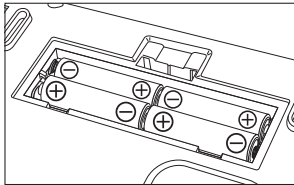

Install the batteries (P.5)

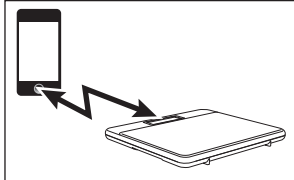

Pair with a receiver (P.6)

Measure without pairing with a receiver (P.7)

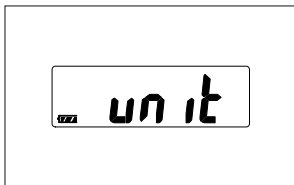

Set the Unit (P.8)

Measuring (P.9)

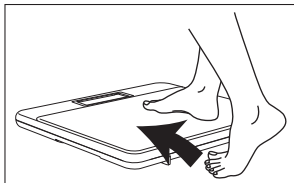

Step on the scale

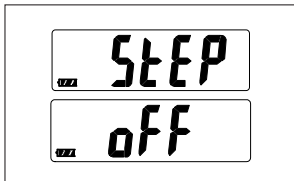

Confirm that StEP and off are alternately displayed

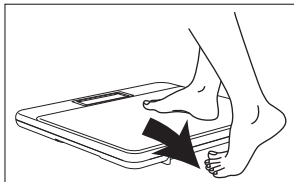

Step off the scale

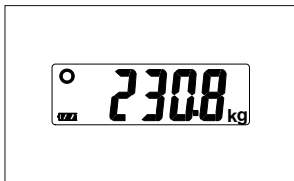

Confirm your weight



Data is transmitted.

Data is stored in the scale if there is no receiver. (P.11)

Receivers can also be unpaired. (P.11)

►► Safety Precautions

The following items contain information to prevent the risk of harm or injury to yourself or other people. Please read these items carefully and be sure to use this product correctly.

 Danger	This symbol indicates "an immediate danger which could result in death or serious injury".
 Warning	This symbol indicates "the possibility of death or serious injury".
 Caution	This symbol indicates "the possibility of physical injury or damage to property".

Precautions for Use

❖ General Precautions

Warning

- Do not rely on self-diagnosis when attempting weight loss or therapeutic exercise. Follow the instructions of a physician or specialist.
- Do not step on the edges of the scale or jump on the scale. It may result in a fall, causing injury. The impact may also cause damage to the scale.
- Do not use the scale on an uneven surface. It may damage the scale. Also, the scale cannot measure accurately.
- Do not use the scale on a slippery surface, or step on the scale with wet feet. It may result in slipping and injury. Also, the scale cannot measure accurately.

Caution

- Do not place the scale where it is exposed to excess water or humidity such as a bathroom, where it is exposed to direct sunlight, where it is exposed directly to the air outlet of an air conditioning unit, or near fire. It may cause the scale to malfunction.
- This scale should only be used for weighing body weight.
- This scale is a precision measuring device. Do not drop the scale, or expose it to vibration or powerful shocks.
- Do not disassemble, repair or modify the scale. It may cause malfunction or injury.
- Persons with disabilities should be assisted by a caregiver when using this scale. Failure to do so may result in a fall, causing injury.
- When installing the batteries, be sure that the + (positive) and - (negative) terminals are correct. Installing incorrectly may cause overheating, battery fluid leaks or rupturing of the batteries, resulting in damage to the scale or injury.
- This scale is designed for personal use.
- Store this scale out of the reach of small children.
- Do not store this scale vertically. If for any reason this scale is stored vertically, be sure not to let the scale fall.
- Do not place any items on this scale during storage.
- If use of this scale is shared with a person who has an infectious disease such as a skin disease on the feet, etc., clean the scale before use.
(For details on cleaning the scale, see "Maintaining the Scale (P.14)".)

▶▶ Wireless Communication Function

This scale uses the Bluetooth wireless to communicate with a receiver device. At the end of measurement, the measurement data is automatically sent from this scale to the receiver device. Bluetooth is communication technology that enables devices to communicate wirelessly. For details on Bluetooth, see "Scale Communication (P.12)".

Receiver Device

This is a device such as personal computer or smartphone on which an application to enable Bluetooth communication with this scale has been downloaded and installed.

Precautions for Wireless Function

⚠ Warning

- Do not use in places where wireless communication is prohibited, such as on airplanes or in hospitals. This scale may have an adverse effect on electronic devices or medical electrical equipment.

⚠ Caution

- If the communication function of this scale is used near a wireless device that communicates in the 2.4 GHz range, the processing speed of both devices may decrease. Do not use near a microwave oven where a magnetic field, static electricity or radio wave interference may occur. (The signal may not reach due to environmental reasons)

A&D cannot accept any responsibility for any losses incurred such as operating malfunctions or loss of data that may occur through the use of this scale.

This scale is not guaranteed to connect to all Bluetooth compatible devices.

▶▶ Accessories

If any of the accessories are missing or damaged, contact the product vendor or an A&D Sales Branch.

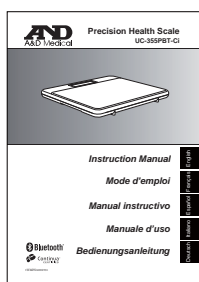

Instruction Manual

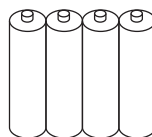

Alkaline Batteries x 4



Tray

►► Parts Names

Scale

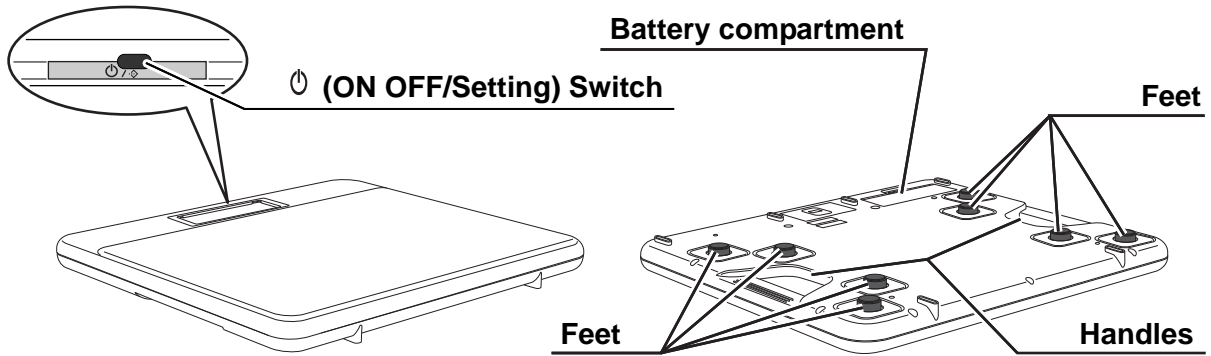

Display Section

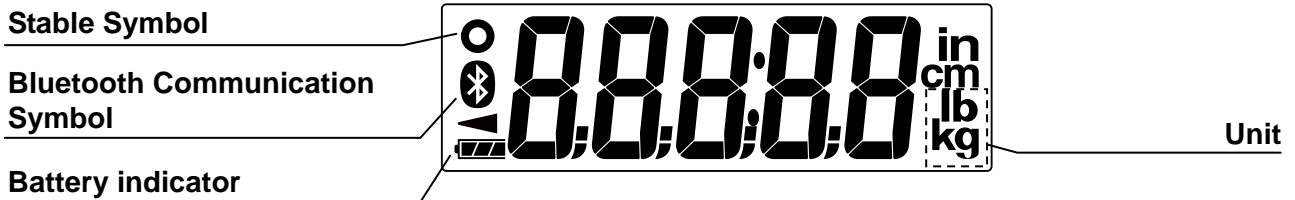

Display Symbols

❖ Display Section

Symbol	Name	Description
	Ready/Stable symbol	This symbol is displayed when the measurement display is stable.
	Battery indicator	The normal battery power indicator with charge remaining.
		If this symbol is displayed, replace all four batteries with new ones.
	Bluetooth Communication Symbol	

❖ Scale Underside

Symbol	Name	Description
	WEEE label	----
CE 06780	CE mark	----

▶▶ Installing (or Replacing) the Batteries

1. Open the battery compartment cover on the underside of the scale.

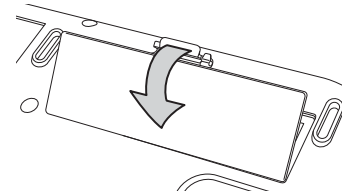

2. Install four new AA size alkaline batteries with the positive (+) and negative (-) terminals properly aligned with the corresponding symbols in the battery compartment.

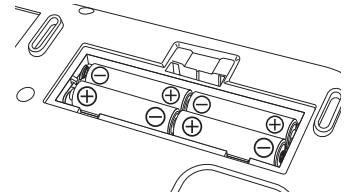

3. Close the battery compartment cover.

- The scale switches to pairing mode when batteries are installed.
To pair the scale with a receiver, see "Registering with a Receiver (Pairing) (P.6)". If you do not want to pair the scale with a receiver, see "Skip Registering with a Receiver (Pairing) (P.7)".

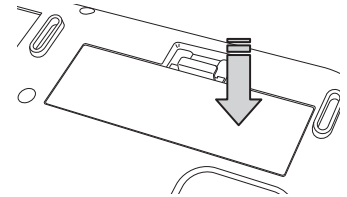

⚠ Caution

- Install each battery with the positive (+) and negative (-) terminals properly aligned with the corresponding symbols in the battery compartment.
- Improper installation of the batteries may cause battery leakage.
- Replace all four batteries with new ones, when the  symbol is displayed.
- Do not mix new and used batteries. It may cause damage to the scale or shorten the battery life.
- Be sure to use AA size alkaline batteries. Do not use any other type of battery.
- Never use rechargeable batteries with this scale.
- The battery life is dependant upon the environmental temperature, battery type and usage.
- The batteries provided with the device are for testing the scale performance and may have a limited life.
- Remove the batteries from the battery compartment, when the scale is not to be used for a long time. Storing the scale with the batteries installed may result in battery fluid leaking from the batteries, causing damage to the scale. The supplied batteries are for checking operation of the scale and may have a short lifespan.

Automatic Power-Off Function

The scale has an "Automatic power-off" function.

- After the measurement results are displayed for 15 seconds, the scale is automatically turned off.

▶▶ Registering with a Receiver (Pairing)

This scale needs to be registered with a receiver in order to use Bluetooth communication with the receiver. The process of registering this scale with a receiver is known as pairing.

When pairing is completed, measurement data from this scale is automatically sent to the paired device each time a measurement is made when the receiver is in the state in which it can receive transmissions. Consult the receiver instruction manual and set it to enable pairing. If the receiver has a "pairing wizard", use the wizard to complete pairing.

Place the receiver and this scale as close as possible to carry out pairing.

1. Install four AA size alkaline batteries into this scale.

- For details, see "Installing (or Replacing) the Batteries (P.5)".

2. Confirm that "Pr" is displayed.

- "  " flashes.
- This scale is discoverable by the receiver.



Pairing can be skipped using the following method.

- i) Press the  switch when "Pr" is displayed.
- ii) Step on this scale when "Pr" is displayed (the scale will automatically switch to measurement).

3. Start pairing on the receiver.

- Follow the pairing instructions for the receiver to search for, select and pair with this scale.
- If a PIN code is requested by the receiver, enter "39121440".

4. Confirm that "End" is displayed.

- Pairing completed.
- If "E-10" is displayed, perform the pairing procedure again from step 1.



This scale can be paired with two receivers.

If this scale is paired with a third receiver, the information of the receiver that was communicated with most recently remains.

Once the scale paired with the receiver, it is no need to perform pairing after replacing batteries.

Cautions for Pairing

- Turn the power of other Bluetooth devices off when performing pairing.
- Multiple devices cannot be paired at the same time.
- If measurement data cannot be received, try pairing again.
- After pairing is complete, all communications are done automatically.
- To unpair a receiver, see "Unpairing (P.11)".
- In the unlikely event that this scale causes radio wave interference to another wireless station, either change the location where the scale is used or stop using the scale immediately.

▶▶ Skip Registering with a Receiver (Pairing)

.....

1. Install four AA size alkaline batteries into this scale.

- For details, see "Installing (or Replacing) the Batteries (P.5)".
-

2. Press the switch when "Pr" is displayed.

- Press the  switch to turn the power off.

You can also measure your weight by simply stepping on the scale when "Pr" is displayed.

.....



▶▶ Setting the Unit

1. Confirm that the scale is turned off, and press and hold the switch.

- When the  switch is continuously pressed, "unit" and "uPr" are alternately displayed.

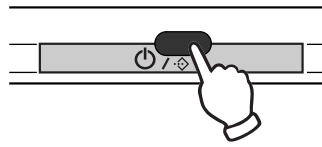

Beep



2. Release the switch when "unit" is displayed.

- The display changes from "unit" to display the unit that is currently set.

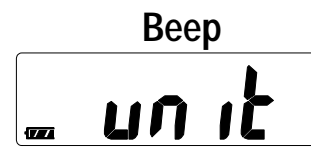
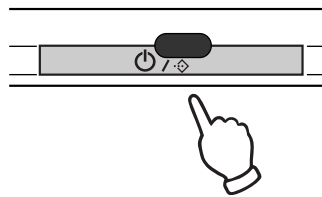

3. Press the switch to select the unit that you want to set.

- The unit changes each time the  switch is pressed.
- Wait for 3 seconds after setting the unit.

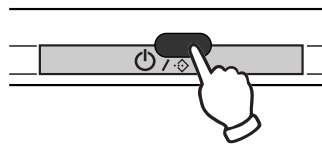

4. Confirm that "End" is displayed.

- The settings are saved.
- After three seconds of non-operation, the scale confirms the selected unit with two beeps, displays "End" and automatically turns off.



▶▶ Measuring Your Weight

Step On Weighing

1. Confirm that the scale is turned off, and step on the scale gently.

- Measurement starts when you step on the scale.
- A progress bar is displayed during measurement. Stand up straight and remain as still as possible during measurement.

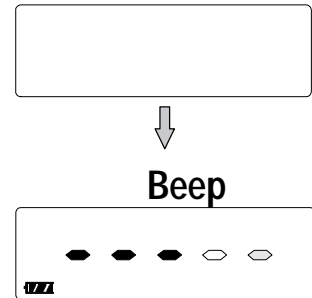

2. Step off the scale when "StEP" and "oFF" are alternately displayed with three beeps.

- If you do not step off, the scale beeps every two seconds.
- The scale turns off automatically after 2 minutes.
- All display segments are indicated when you step off the scale.
- Do not touch the scale while all display segments are indicated. It may cause misreading.

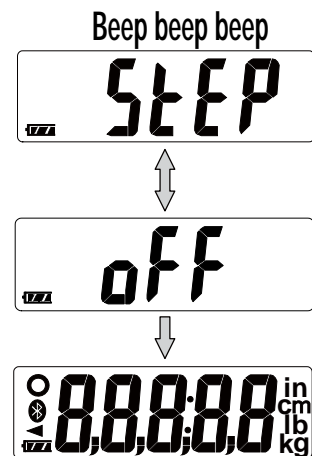
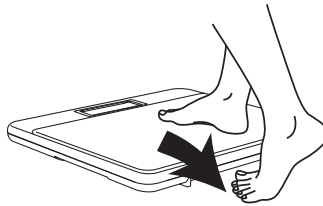

3. Confirm the measurement results.

- The scale turns off automatically 15 seconds after the measurement results are displayed.
- Data is automatically sent to the receiver if the receiver is in the receivable state.
- If the scale is not paired with a receiver, the data is stored in the scale memory. (See "Transmitting Temporarily Stored Data (P.11)".)
- Data stored in the scale memory cannot be viewed on this scale.
- You can also shut the power off by pressing the  switch.



Measuring Your Weight on a Carpet

Place the scale on a solid level surface, such as tile, wood, or laminate flooring.
If the scale must be used on a carpet, be sure to use the supplied tray.

1. Place the supplied tray on the carpet.

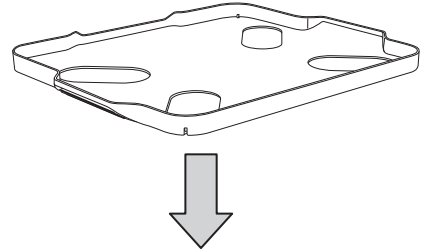

2. Place the scale onto the tray in line with the illustration on the tray.

- Set the scale so that sides of the scale do not touch the tray.
You may not be able to accurately measure your weight in some cases.

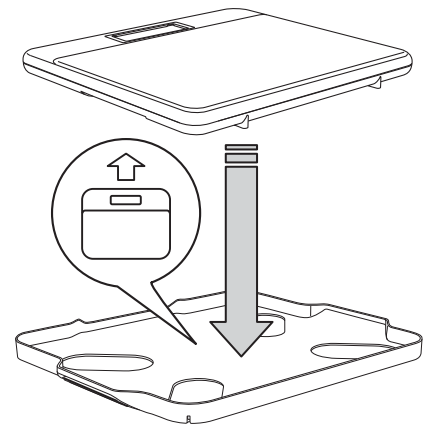

3. Measure your weight.

- To measure your weight, see "Step On Weighing" (P.9).
- If the measurement results are greatly different from the expected values, place the scale on a solid level surface.
- Do not use the tray for any other purposes than the specified purpose.

Warning

- Do not use the tray in a slippery location. It may result in slipping and injury.
- Set the tray so that the non-slip pads are on the floor. Setting the tray incorrectly may cause damage to the tray or scale, or injury.

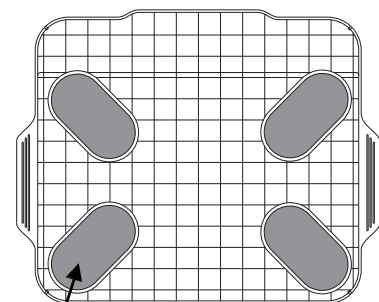

Non-slip pad

▶▶ Other Functions

Unpairing

1. Confirm that the scale is turned off, and press and hold the  switch.

- When the  switch is continuously pressed, "unit" and "uPr" are alternately displayed.

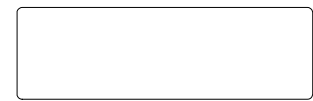
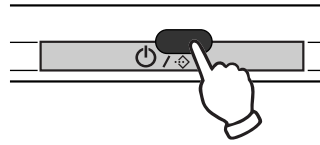

Beep



2. Release the  switch when "uPr" is displayed.

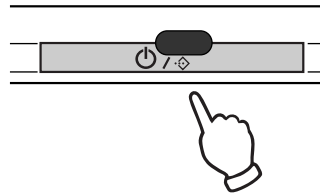

Beep

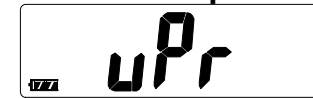

3. Confirm that "End" is displayed.

- The receiver is unpaired.
- If "E-10" or "E-11" is displayed, perform the unpairing procedure again from step 1.
- The scale turns off automatically.

Beep beep

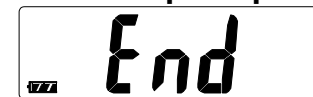

Transmitting Temporarily Stored Data

If measurement data cannot be sent to a receiver, this scale can temporarily store data of a maximum of 200 measurements in the built-in memory. When the scale is able to transmit to a receiver, all of the data is transmitted. If the amount of data temporarily stored exceeds 200 measurements, the oldest data is deleted and replaced with new data.

Stored data cannot be viewed on this scale.

The maximum amount of data that can be temporarily stored may differ depending on the receiver.

Scale Communication

This scale is equipped with a Continua certified Bluetooth wireless communication function. Measurement data can be transmitted by connecting to a Bluetooth device that is compatible with Continua connection specifications.



Continua™ CERTIFIED Devices that are Continua certified carry the Continua logo mark.



Bluetooth® Bluetooth devices carry the Bluetooth logo mark.

- For details on pairing this scale with a receiver that is equipped with Bluetooth, see "Registering with a Receiver (Pairing) (P.6)".
Also refer to the pairing instruction manual of the receiver that you want to pair with.

Ensuring a Good Connection

- Ensure the space between this scale and the receiver is unobstructed. The communication distance may be shortened due to the building construction or other obstructions. In particular, communication may not be possible through reinforced concrete walls, etc.
- Do not use the Bluetooth connection near a wireless LAN or other wireless equipment, near devices that emit electro-magnetic waves such as microwave ovens, locations that have a large number of obstructions, or other poor environments for radio waves. It may cause the connection to be frequently interrupted, communication speeds to drop substantially, and errors to occur.
- When used near an IEEE802.11g/b/n wireless LAN device, the devices cause mutual radio wave interference, and the communication speed may drop or connection may be impossible. In this situation, turn the power of the device that you are not using off, or change the location where it is used.
- If the scale does not communicate properly when used near a wireless device or broadcast station, change the location where it is used.

Caution

- The communication distance between this scale and the receiver depends on the Bluetooth output class of the receiver.
For Class1 Bluetooth receivers: Max. 100 m
For Class2 Bluetooth receivers: Max. 10 m
This distance may become shorter due to the surrounding environment; therefore check that the distance is close enough for data to be transmitted after the measurement.

Time Settings

This scale has a built-in clock. The date and time of measurement are included in the measurement data. The clock is synced with the clock in the receiver. For details on the clock specifications, see the instruction manual of the receiver.

►► Specifications

Model	UC-355PBT-Ci
Maximum capacity	250 kg / 550 lb
Minimum display	0.1 kg units from 0 to 100.0 kg 0.2 kg units from 100.0 to 250.0 kg 0.2 lb units from 0 to 220.0 lb 0.5 lb units from 220.0 to 550.0 lb
Communication method	Bluetooth Ver.2.1 class 1 SSP HDP Compatible
Setting Items	Units: kg or lb
Power source	Four AA size alkaline batteries
Battery life	Approx. 1 year (two measurements per day when alkaline batteries are used)
Dimensions	360 (W) × 415 (D) × 38 (H) mm
Weight	Approx. 4.3 kg (including batteries)
Accessories	Instruction manual, Alkaline batteries, tray

❖ Compliance with European Directives



The scale complies with the statutory EMC (Electromagnetic Compatibility) directive 2004/108/EC. The WML-40AH is approved in accordance to R&TTE directive transmitter module marked by **CE 0678** , manufactured by MITSUMI incorporated to OEM product.

Notes: Indoor use only. The displayed value may be adversely affected under extreme electromagnetic influences.





❖ Compliance with FCC Rules

The scale complies with part 15 of the FCC rules and contains the FCC ID POOWML-C40.

❖ Compliance with Industry Canada

IC: 4250A-WMLC40.

▶▶ Before Requesting Service

Symptoms	Corrective Action
E is displayed	Exceeds the maximum capacity (250 kg / 550 lb).
E-0 is displayed	Exceeds the maximum capacity (250 kg / 550 lb).
Err is displayed	Exceeds the maximum capacity (250 kg / 550 lb).
E-10 is displayed	Pairing or unpairing has not completed correctly. Remove and reinstall the batteries.
E-11 is displayed	
H is displayed	Exceeds the maximum capacity (250 kg / 550 lb).
 is displayed	Remove and reinstall the batteries. Or replace all four batteries with new AA size alkaline batteries.
Nothing is displayed when the  switch is pressed	
The measurement results are greatly different from the expected values.	Place the scale on a solid level surface. When the scale is placed on a carpet, be sure to use the supplied tray.
	Remove any foreign objects that might be touching the bottom of the scale.
Measurement doesn't start when I step on the scale.	Did you press the  switch when stepping on the scale? Place the scale on a hard floor, and press the  switch before measuring.

▶▶ Maintaining the Scale

- If the scale becomes dirty, soak a cloth in water or mild detergent, wring the cloth out thoroughly and then wipe the scale clean.
After wiping away the dirt with the damp cloth, dry the scale using a soft, dry cloth.
- Never use alcohol, benzene, thinner or other harsh chemicals to clean the scale.
- Remove the batteries from the battery compartment, when the scale is not going to be used for a long time



A&D Company, Limited

1-243 Asahi, Kitamoto-shi, Saitama 364-8585 JAPAN

Telephone: [81] (48) 593-1111 Fax: [81] (48) 593-1119

A&D INSTRUMENTS LIMITED

Unit 24/26 Blacklands Way, Abingdon Business Park, Abingdon, Oxfordshire
OX14 1DY United Kingdom

Telephone: [44] (1235) 550420 Fax: [44] (1235) 550485

A&D ENGINEERING, INC.

1756 Automation Parkway, San Jose, California 95131 U.S.A.

Telephone: [1] (408) 263-5333 Fax: [1] (408) 263-0119

A&D Australasia PTY LTD

32 Dew Street, Thebarton, South Australia 5031 AUSTRALIA

Telephone: [61] (8) 8301-8100 Fax: [61] (8) 8352-7409